



www.facebook.com/ngasales corporation/



www.googleMaps/NGA SALES CORPORATION/



www.Linkedin/NGA SALES CORPORATION



CORPORATE OFFICE

2729/2, Street no. 1,
Baba Gajja Jain Colony, Moti Nagar,
Ludhiana -141010, Punjab (INDIA)
Mobile: +91-78375-77000, 82830-59778
Email: ngasales777@gmail.com

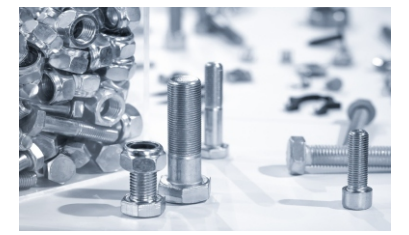

Manufacturers & Exporters of :
INDUSTRIAL AND ENGINEERING FASTENERS

High Tensile Fasteners | Special Fasteners As per Drawings | All Kinds of Nuts, Bolts and Washers

Director's Desk



The Managing Director Mr. Naresh Kumar himself is having 25 Year's practical experience in this field and resulted the international export quality comes out as a final product from our company to satisfy the customers years and years.

I feel Proud to say that " NGA " has always given more than the expected results and to support the increasing customers demand. Latest technology is being regularly upgraded through R & D department



THE FASTENERS EXPERTS

Our Mission:

NGA Fasteners is committed to providing its customers products with a very competitive relation between price/quality, guaranteeing high levels of customer service, by means of a group of trained and motivated employees who assure the satisfaction of our clients. To make you count on us.

Journey To Excellence

Excellence is earned through hard work and dedication to manufacture world class quality product. At **NGA** , we live by these words everyday.

Since 2012, we have been committed to manufacture the best Industrial and engineering Fasteners. This ongoing commitment doesn't stop with the manufacturing process itself. We strongly believe that the real attributes of a great company are to treat every customer with utmost respect and satisfy their every need the first time and every time. Our Customers appreciate this dedication to Total Customer Satisfaction and have rewarded us with Strong term Relationships.

To build strong relationships, one has to firstly gain respect in the eyes of its customers. Most of the respect we have attained comes from our long term commitment to quality.

This dedication has allowed us to deliver the height quality products on a timely basis and at a fair price. This journey doesn't end here, we will continue to search for a new ways to improve, to deliver higher quality products to our reputed valued customers and most importantly, maintain the highest ethics in our pursuit of Excellence.

Distribution Network

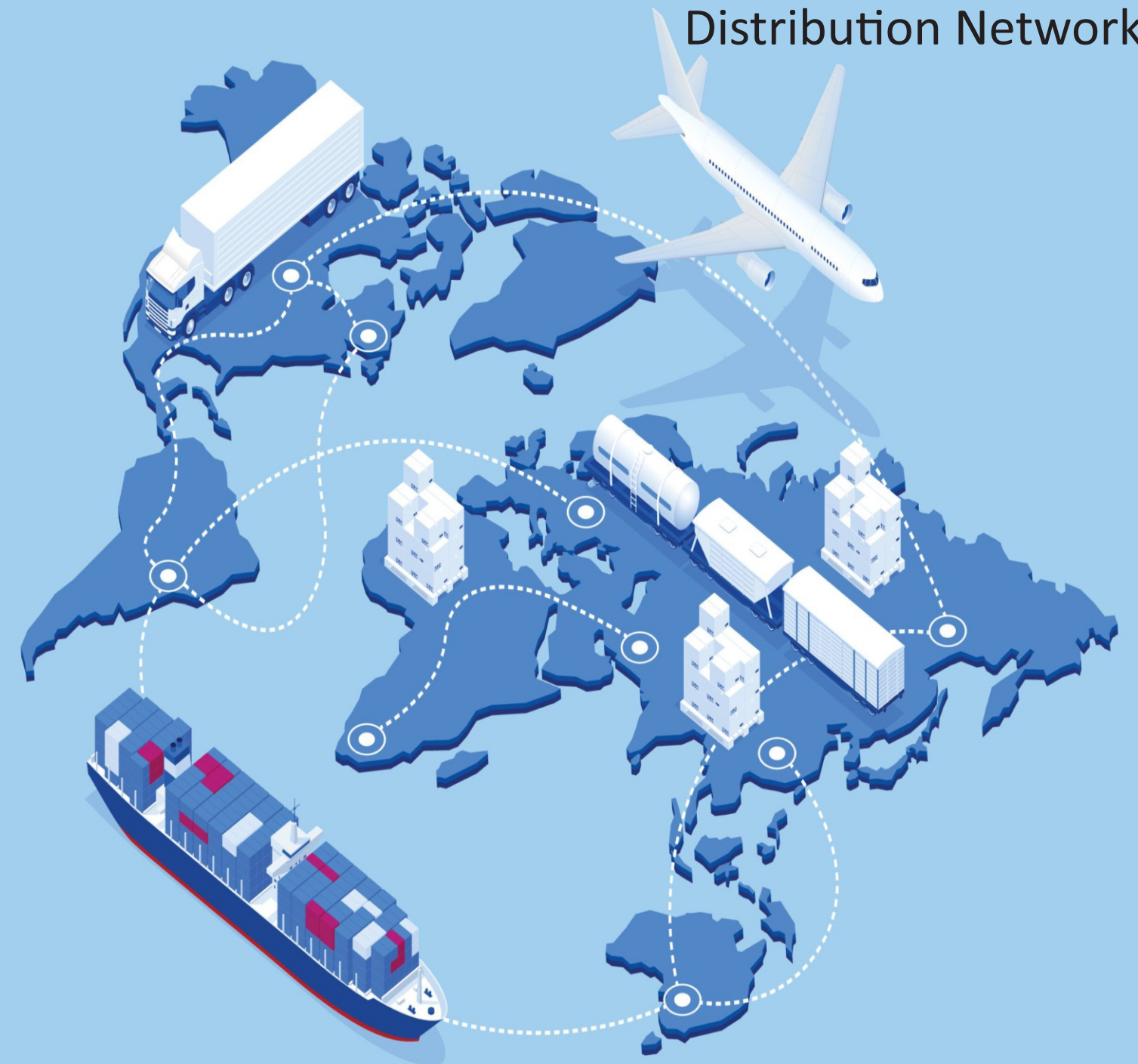

N.B. In case any technical information about the products is required you may contact our head office at Ludhiana . However you may contact our local representative with regard to your queries relating to price , availability of material , delivery schedules etc.



Quality Policy

We are committed for Sustained Growth & Satisfaction of Customers through achieving Innovative Business, Technological, Management Practice & Improving their effectiveness continually

Philosophy

- Understanding & Serving the needs of the Customers
- Creating good working environment for our employees
- Providing distinctively superior value to the global market
- Always serving best Quality Products to customer



Design & Development

In- house facilities for design using latest designing softwares result in fast development & delivery quality Industrial and Engineering Fasteners.

Our tool room designs and develops Dies, Fixtures and Special Purpose Machine Tools in-house which helps to reduce product cost and maintain better quality product.

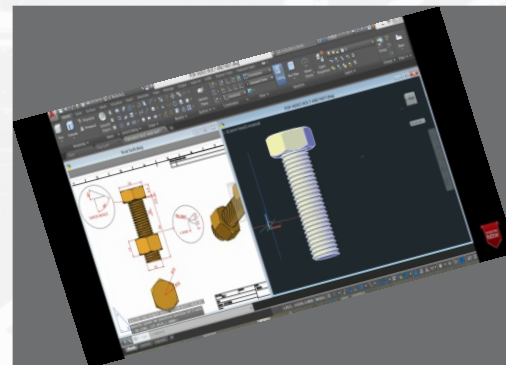

Manufacturing Facilities

As a manufacturing company, over the years we have many capacities, built up technologies and invested in equipments which helps to become a " One Stop Shop for Industrial and Engineering Fasteners ".

- Cold Forging Facility
- Hot Forging Facility
- Bar Drawing Facility
- Heat Treatment Facility
 - Carburising
 - Hardening
 - Tampering
 - Annealing
- Induction Hardening
- Machining Facility
 - CNC / VMC Turning Centers
 - SPM's / Turning Block
- Surface Treatment
 - Phosphating
 - Auto Black
 - Zinc Electro - Plating
 - Powder Coating
- Tool Room
- Testing Facility
 - Chemical
 - Physical
 - Structural Analysis
- Metallurgical Laboratory

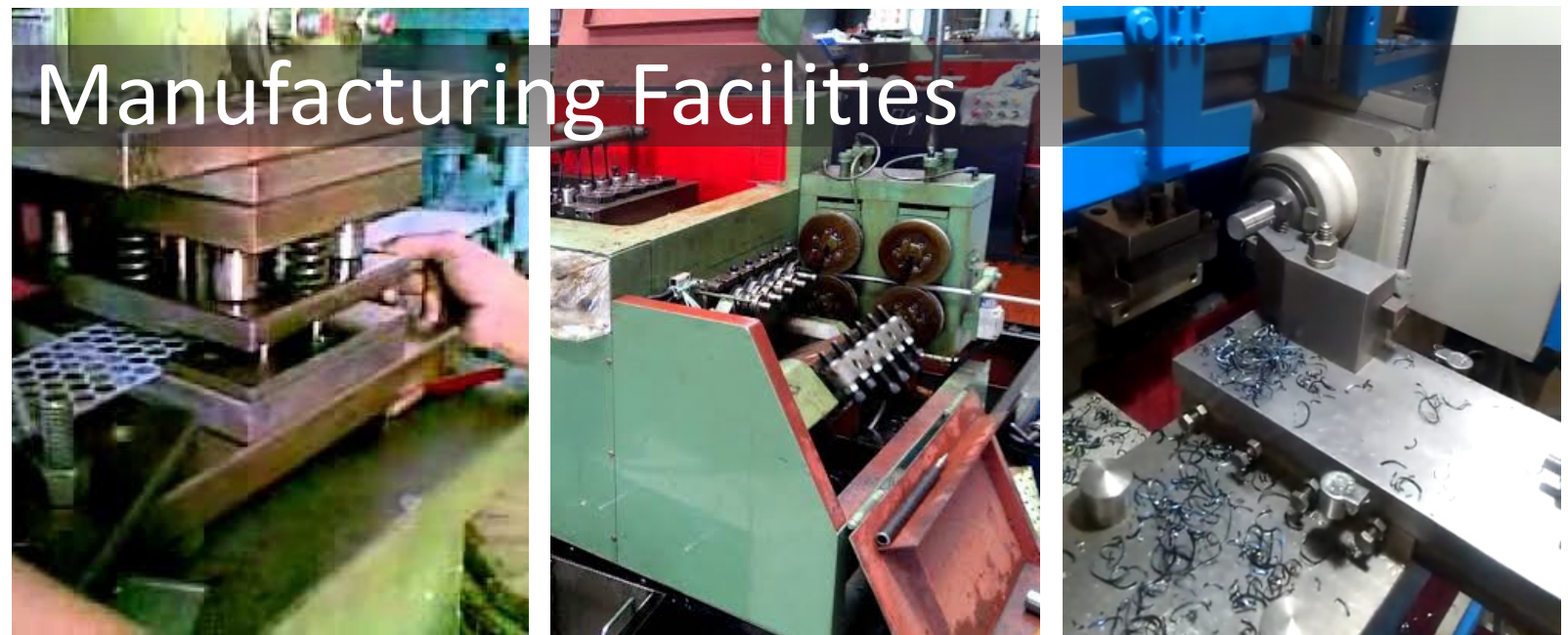

We have in house facility for plating like :
Hot dip Galvanize , Cadmium, Electro - Galvanize -Golden/Zinc/Green plated,
Mechanical Galvanize , Lead plating , Copper plating, Black ETC



Our Competitive Products Nuts

Nuts

Nuts

Diameters:

2MM to 100MM or 3/16" to 4"

Range of Nuts:

- Cage Square Nuts
- Castle Hex Nuts
 - Thick Castle Nuts
 - Thin Castle Nuts
- Collar Nuts
- Crimp Nuts
 - Flange Crimp Nuts Two Side (Hot Forge)
 - Flange Crimp Nuts Three Side
 - Turned Crimp
- Collar Nuts
- Crimp Nuts
 - Flange Crimp Nuts Two Side (Hot Forge)
 - Flange Crimp Nuts Three Side
 - Turned Crimp
- Cup / Close Nuts
- Dome Nuts
- Eye Nuts
- Flange Hex Nuts
- Full Hex Nuts
 - Turned
 - Cold Forge
- Lock Hex Nuts
- Locking Counter Nuts (Press)
- Long Nuts
- Pinion Hex Nuts
- Press Mix Nuts
- Prevailing Torque Nuts

- Rectangular Nuts
- Round Nuts
- Self Locking Hex Nuts
 - Flange (Nylon Insert)
 - Flange (Metal Insert)
- Sheering Nuts / Anti Theft Nuts
- Slotted Nuts (Hex / Round)
- Spring Nuts
- Square Nuts
- T Nuts
- Weld Nuts
- Wheel Hex Nuts
- Wing Nuts / Wedge Nut
 - Press / Casting / Forging
- Flange Dome Nuts
 - Single / Two Pieces
- Nylone Nuts
- Hex Nuts (Washer Face)
- Special Nuts

Grades:

Nuts are made of Grade 4, 5, 6, 8, 2H

other Grades also available as per customer requirement

Finish / Colours:

Finish / Colours:

Hot Dip Galvanized (HDG)

Zinc Plated

Yellow Plated

Self / Black / Natural

Cadmium / Tin Plated

Mechanical



Nuts

Our Competitive Products



Hex slotted Nuts



Hex Lock Nut

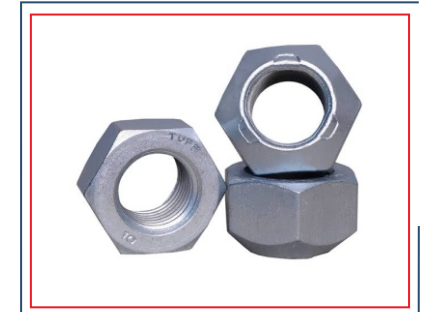

Prevailing torque Nuts

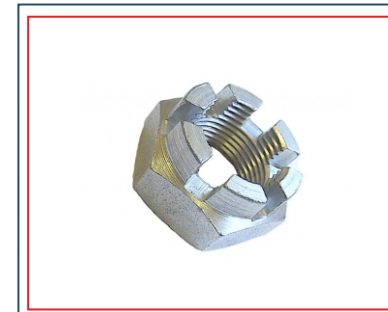

Hex Castle Nuts



Hex Nut washer face



Cap close Nuts



Long/Coupling Nuts



Dome Nuts



Flange dome nuts



HSFG Nuts



Riveting Nuts



Crimp Nuts (Turned)



Our Competitive Products Nuts



Crimp nuts (Knurling Turned)



Check Nuts



S/L Flange Nuts (metal insert)



Crimp flange Nuts (Three side)



Rectangular Nuts



Centre locking nuts



Crimp flange Nuts (Two side)



Hex pinion Nuts



Wing Nuts castings



Flange Nuts



Hex flange slotted nuts



Collar Nuts

Nuts



Nuts



Square nuts



Hex wing nut



Hex weld nuts



Wheel Nuts

Our Competitive Products



S/L Flange Nuts (nylock insert)



Locking nuts



Wing nuts (forging)



Nylock insert nuts



Turned Crimp nuts



Square weld nuts



Hex full S/L nuts (metal insert)



Wing nut (rubber moulding)



Our Competitive Products Nuts



Wing Nuts (Press)



T Nuts



Round Nuts



Cage Nuts



Spring Nuts

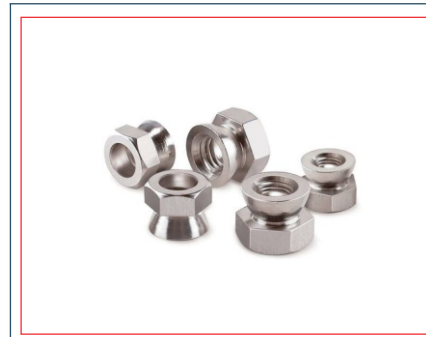

Anti Theft / Sheering Nuts



Nylone Nuts



Eye Nuts



Some of our Special Nuts

Nuts



Washers

Range of Washers:

- Conical Washers
- Cut Type Washers
- Disk Washers
- Fan Disk Washers
- Friction Grip Washers
- Heavy Washers
- Machine Washers
- Multi Tooth Lock Serrated Washers
 - Internal Teeth
 - External Teeth
 - Combine Teeth
 - Over Lapping
- Pack Washers
- Plain Whole Circular Washers
- Punched Round Washers
 - Fiber
 - Nylon
 - Aluminium
- Push Button Washers
- Round Washers for Self Locking Nuts
- Semi Machine Washers
- Shim Washers - Spring Steel
 - Square Section / Flat Section
 - Serrated / Plain
- Square Washers
- Tab Washers
- Tapper Washers
- Wave Washers

Finish / Colours:

- Hot Dip Galvanized (HDG)
- Zinc Plated
- Golden Plated
- Self / Black / Natural
- Cadmium / Tin Plated
- Mechanical

Our Competitive Products





Our Competitive Products Nuts

Washers



Heavy Washers



Plain whole circular washers

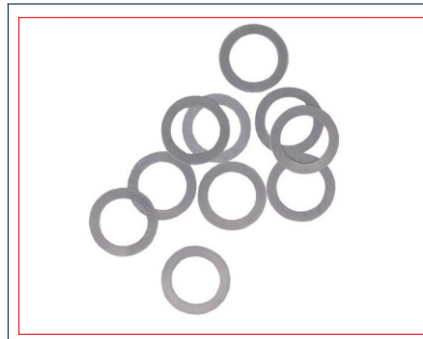

Shim / Pack Washers



Disc Washers

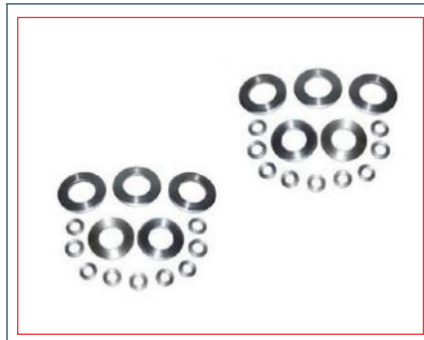

Machine Washers



Semi Machine Washers



Fiber Washers



Wave Washers



Serrated Punch Washers



E/T Multi Tooth Lock Washers



I/T Multi Tooth Lock Washers



Combine Teeth Washers



Washers

Our Competitive Products



Push button washer



Fan disc washer



Conical Washers



Tab washer



HSG washers



Circlip Washers

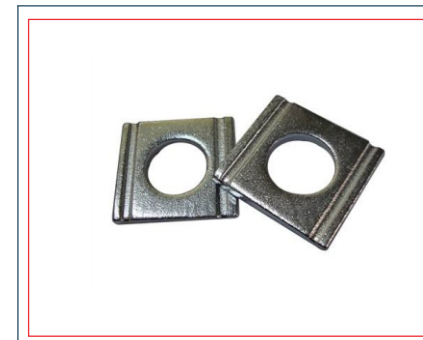

Taper washers



Square Washers



Cut type washers



Serrated Spring Washers



Square Flat

Spring Washers

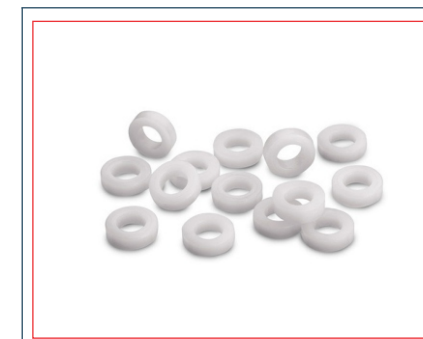

Nylon Washers



Our Competitive Products



Bolts & Screws

Bolts

Diameters:

5MM to 100MM or 3/16" to 4"

Threads:

MM, BSW, BSF, UNF, UN, NC

Grades:

Bolts are made of Grade 4.6, 4.8, 5.6, 5.8, 6.8, 8.8

Other Special Grades are available as per customer requirement

Finish / Colours:

Hot Dip Galvanized (HDG)

Zinc Plated

Yellow Plated

Self / Black / Natural

Cadmium / Tin Plated

Mechanical



Range of Bolts:

- Allen Counter Sunk Head Screws
- Allen Socket Head Cap Screws
- Benjo Bolts
- Bucket Bolts
- Carriage Bolts
- Center Bolts
- Cheese Head Bolts
- Coach Bolts
- Collar Bolts
- Counter Shank Bolts
 - Allen Type
 - Phillips Type
 - Slotted Head Type
- Counter Shank Square Neck Bolts
- D Head Bolts
- Eye Bolts
- Fish Bolts (Cup Oval Neck Bolts)
- Foundation Bolts
- Friction Grip Bolts
- Hammer Bolts
- Hex Bolt Screws
- Hex Flange Bolts
- Hub Bolts
- J Bolts
- L bolts
- Eye / Lifting Eye Bolts
- Mix Bolt Fasteners
- Nib Bolts
 - CSK
 - Round Head
- Pan Head Bolts
 - Phillips
 - Slotted Head
- Rack Bolts
- Slotted Round Head Bolts
- Self Taping Screws
- Socket Button Head Cap Screws
- Socket Counter Sunk Head Screws Allen
- Hammer Bolts

Our Competitive Products

- Special Drill Process
- Square Head Bolts
 - CSK
 - Flat Neck
- Step Bolts
- T Bolts (Flat & Round Head)
- Nylon Bolts
- Grub Screws
 - Allen
 - Slotted
- Track Show Bolts



Our Competitive Products

Bolts & Screws



Flange Bolts



Hex Plug



Collar Flange Bolts



Collar Bolts

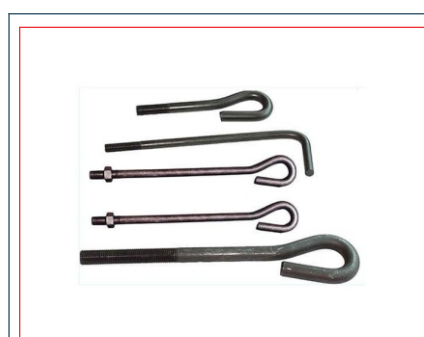

Foundation Bolts



HSFG Bolts

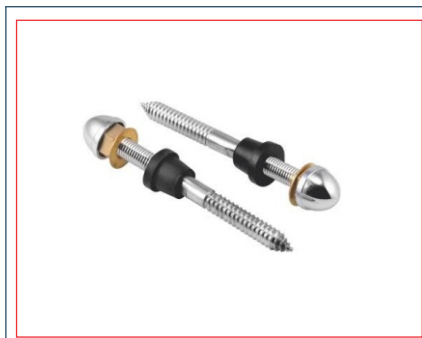

Rack Bolts



Rectangular Head Bolts



Square Head Bolts

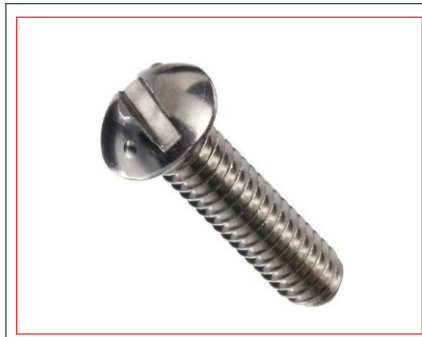

Slotted Round Head Bolt

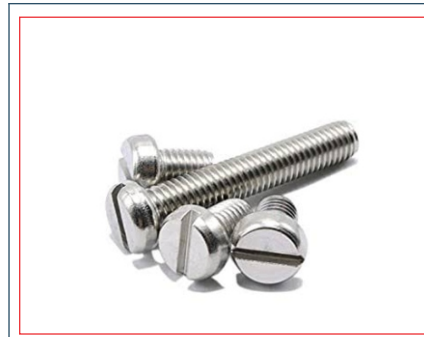

Slotted Cheese Head Screw

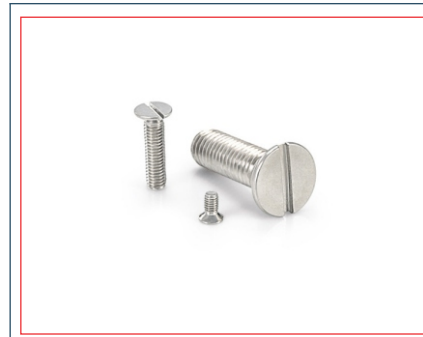

Slotted CSK Head Screws



Bolts & Screws

Our Competitive Products

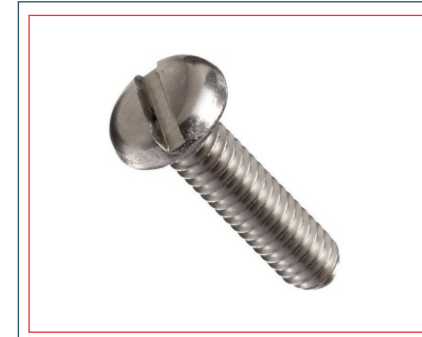

Slotted Pan Head Bolts



Slotted Grub Screws

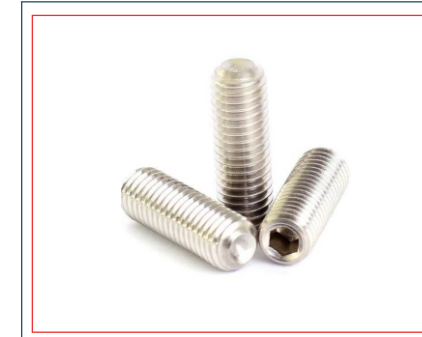

Allen Grub Screws



Hex Bolts

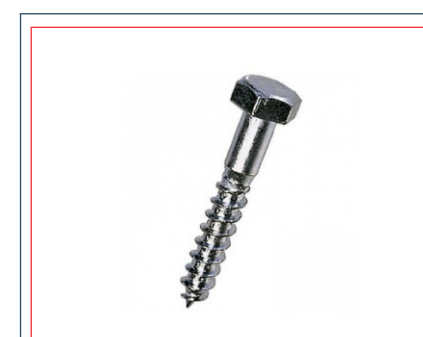

Hex Coach Bolts



Coach Screws



Hub Bolts

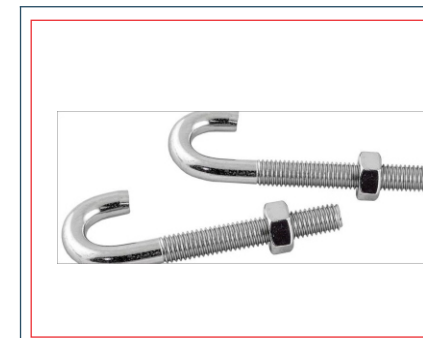

J Bolts



Step Bolts



U Bolts



L Bolts

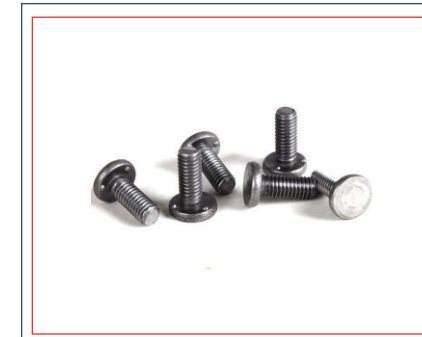

Weld Bolts



Our Competitive Products

Bolts & Screws



Nib Bolts

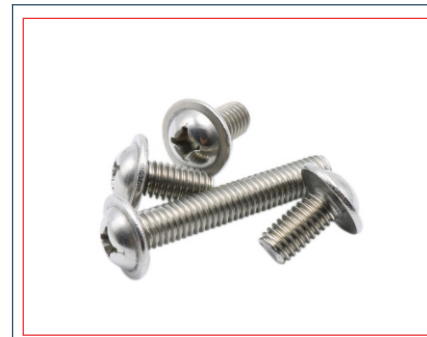

Philips Pan Head Screw

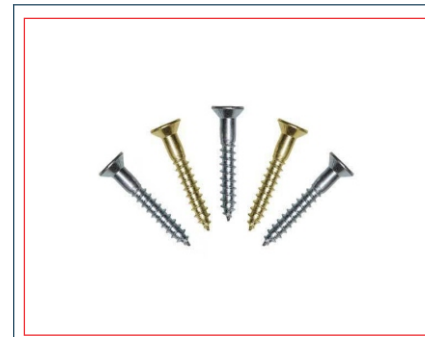

Self tapping /wood screws

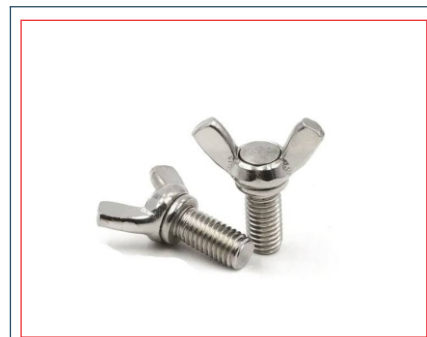

Wing Screws



Fish Bolts



Socket Button Head Screws



Allen CSK Head Screws



CSK Bolts



Square Head Bolt CSK Neck



Slotted Head Cap Screws



Counter Sunk Philips Head Screws



Banjo Bolts



Bolts & Screws

Our Competitive Products



Bucket Bolts



Hammer Head Bolts

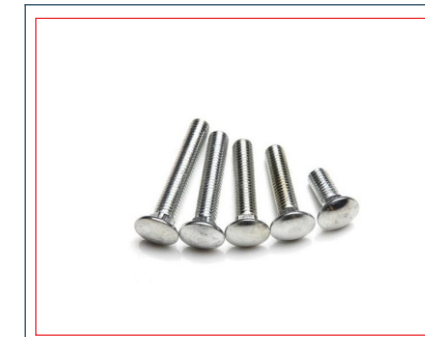

Carriage Bolts



Center Bolts



Counter Shank Square Neck Bolts



Nylone Bolts

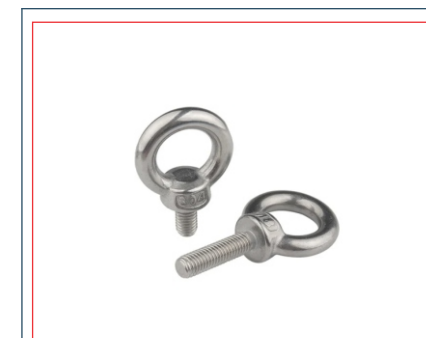

Eye Bolts

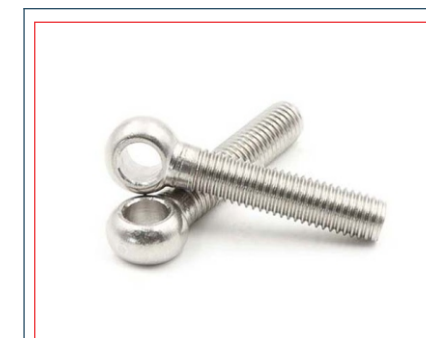

Eye Lifting Bolts



D Bolts

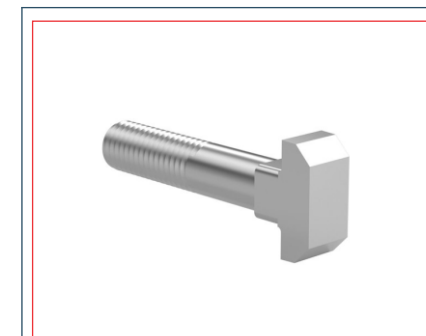

Flat T Head Bolt



Round T Head Bolt



Track Shoe Bolts



Our Competitive Products Scaffolding & Other Products



Bottom & Top Cups



Cup Nut



Prop Nuts



Jack Nut



Pipe



Split Pins



Swivel & Right Angle Coupler



Rivets



Flanges

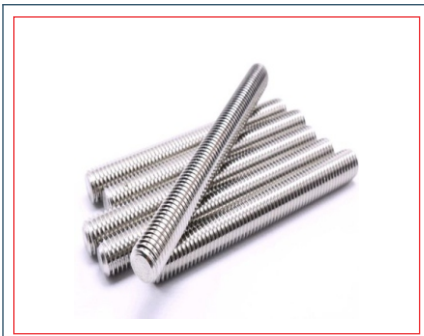

Thread Bar



Studs / D Studs



Allen Wrenches



Scaffolding & Other Products Our Competitive Products

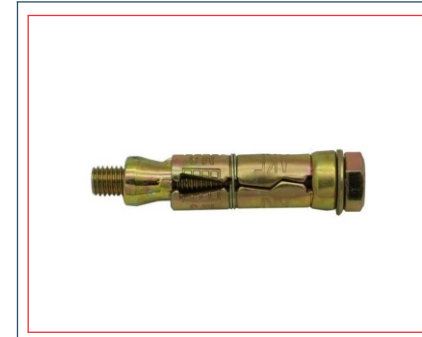

Rawl Bolts



Zebra Pin Type



Projection Bolts



R Spring



L hooks



D Hooks



Bushes



Linch Pin



Hinges



Press Components





Our Competitive Products

Special Fasteners



Special Fasteners

Our Competitive Products

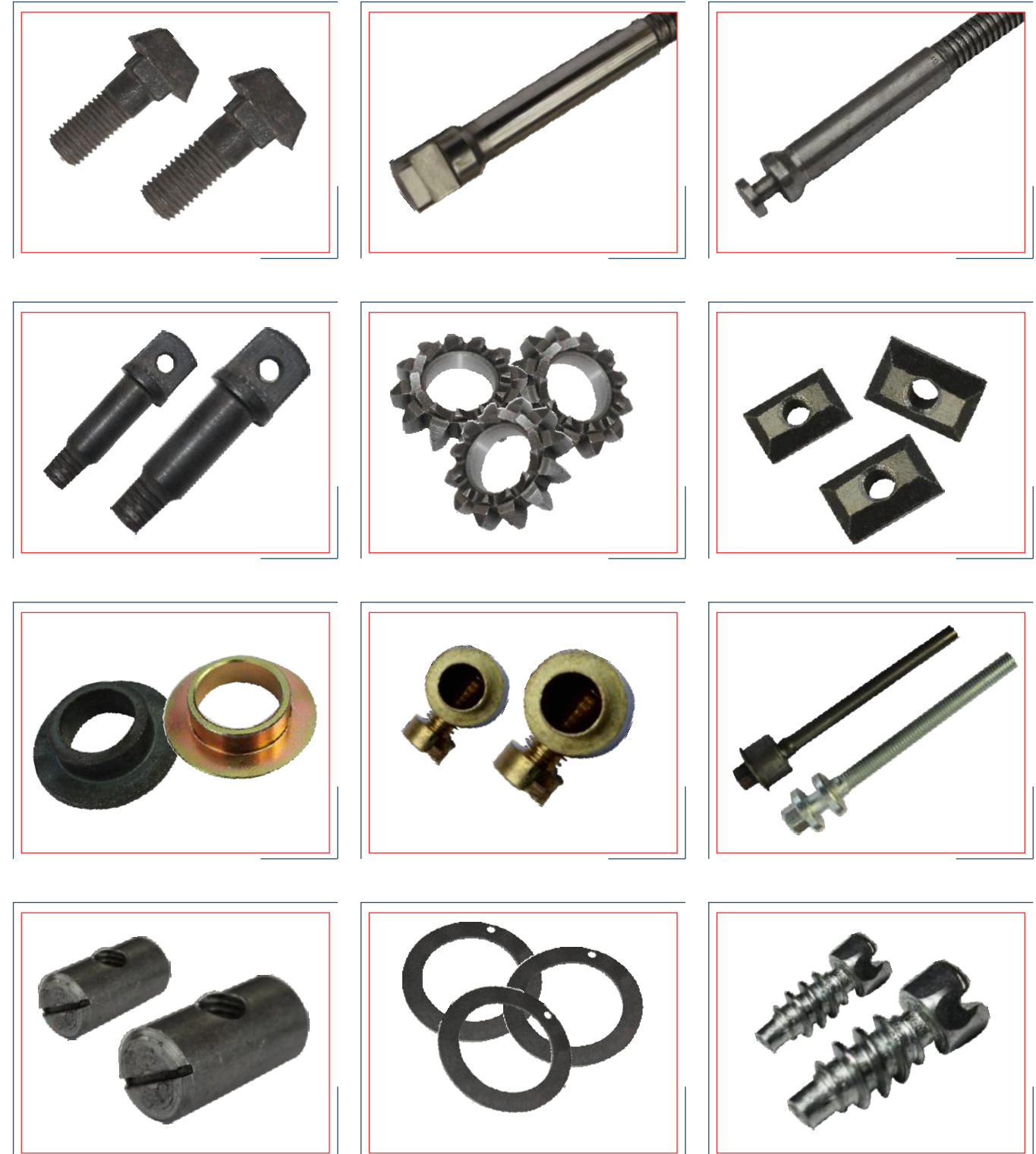



Our Competitive Products

Special Fasteners



Special Fasteners

Our Competitive Products





Our Competitive Products

Special Fasteners



Special Fasteners

Our Competitive Products





Application



Construction



Automobile industry



Turbines



Chemical industry



Transport



Railways



Construction



Power Stations



Our clients

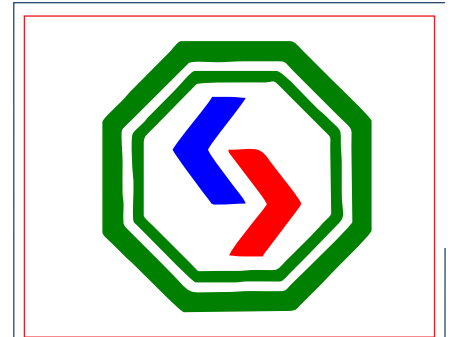
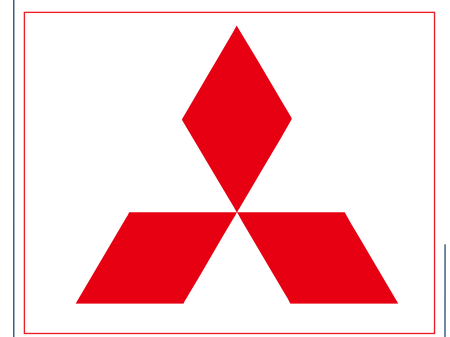

Manufacturing Facilities

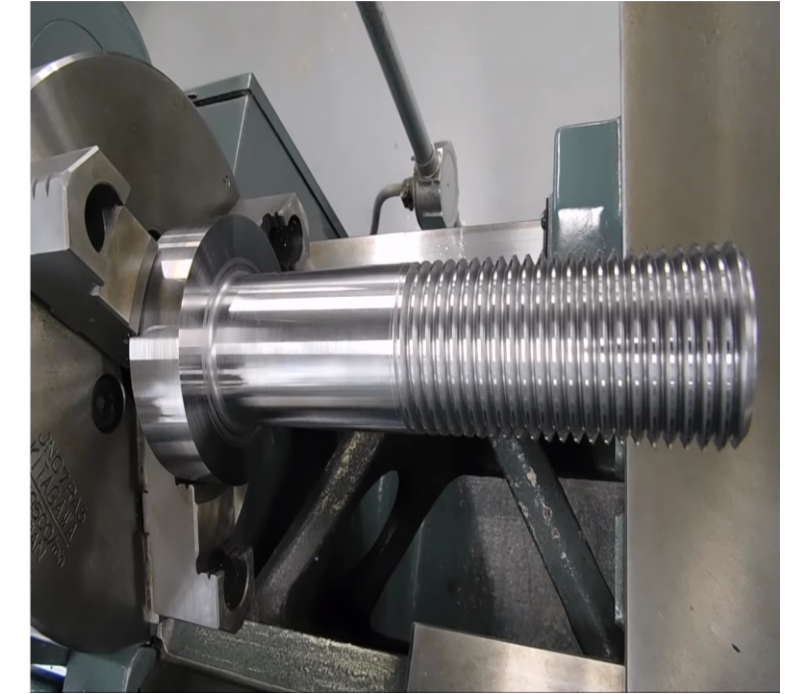
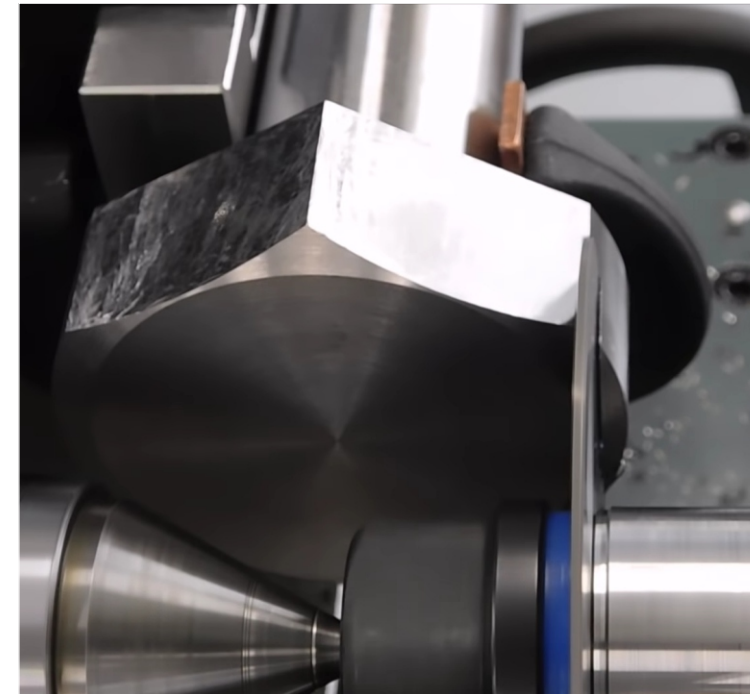
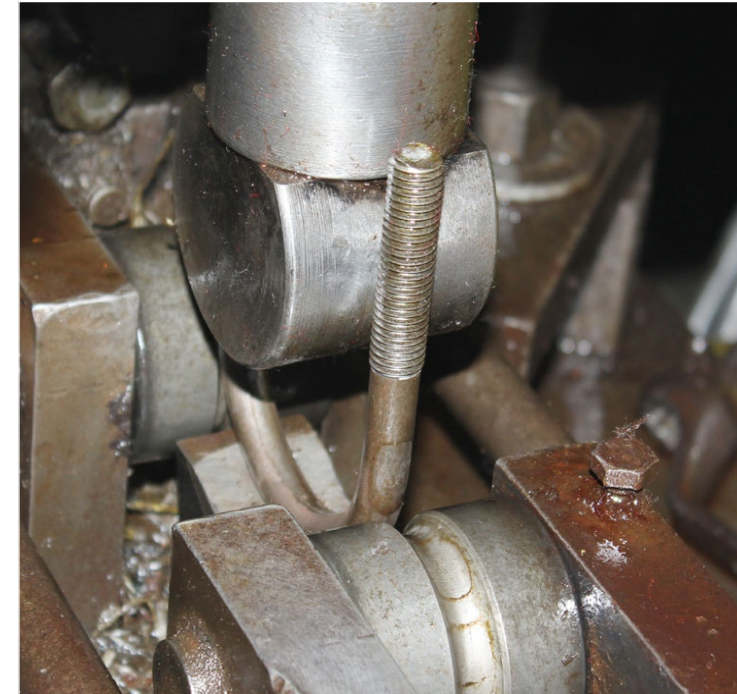
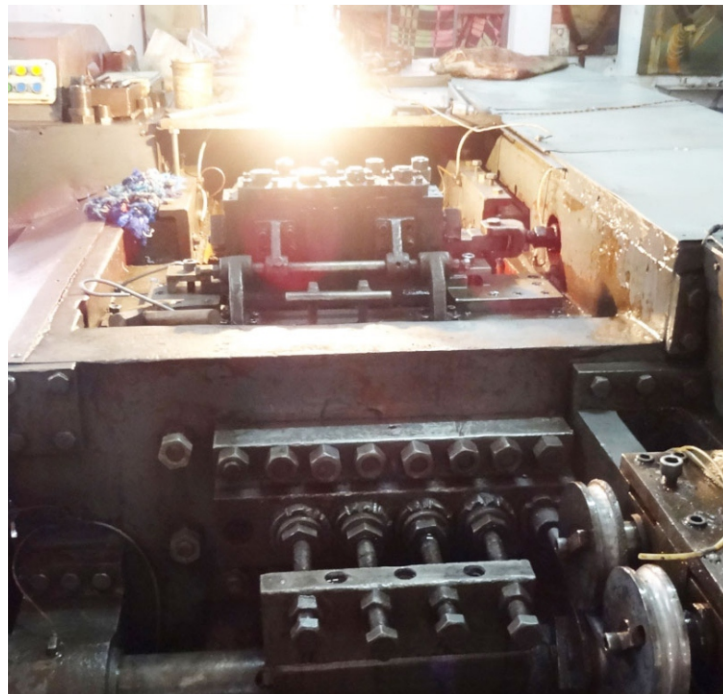



Testing Facilities



Stock and Inspection



Tensile Testing



Plug gauge

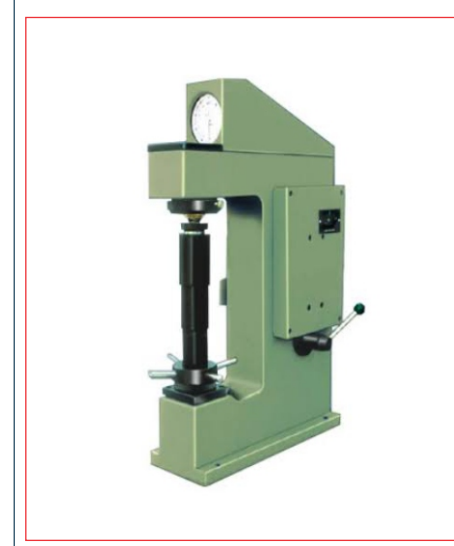

Rockwell hardness testing

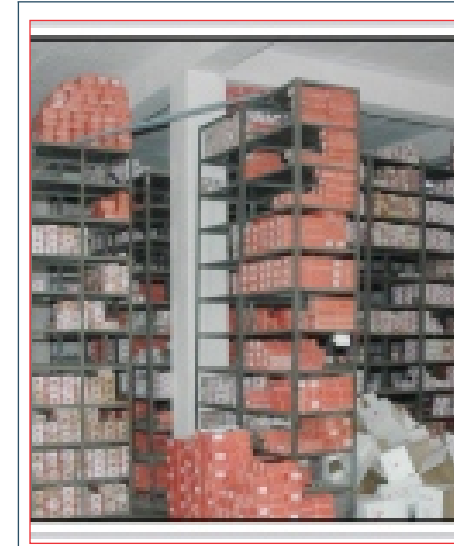

Stock room

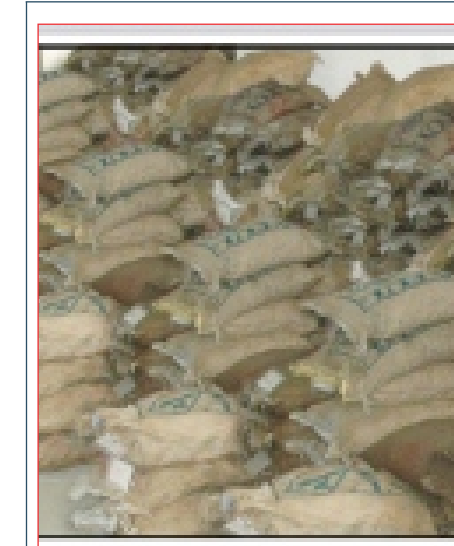

Bulk packing

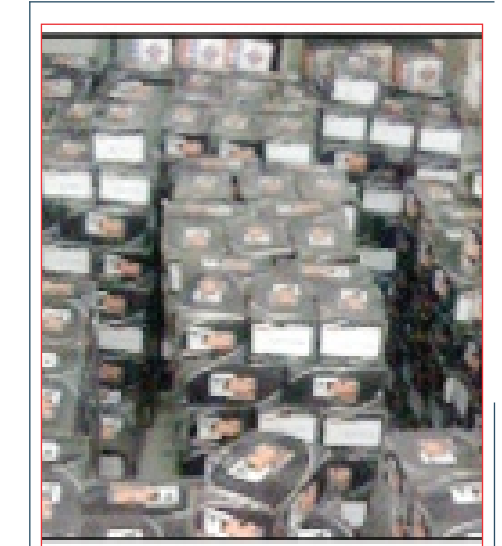

Export box packing



Double shear test



Torsion testing



Ring gauge



Box Packing

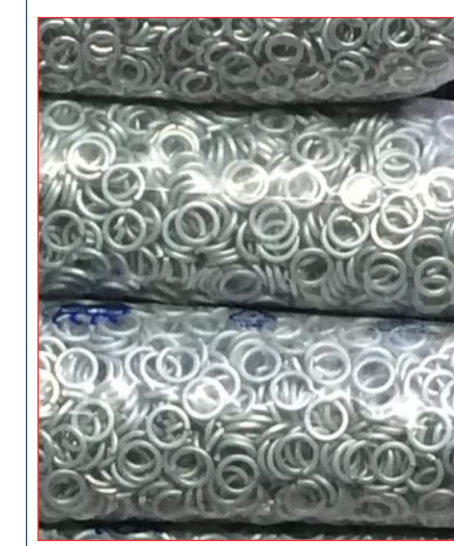

Packing

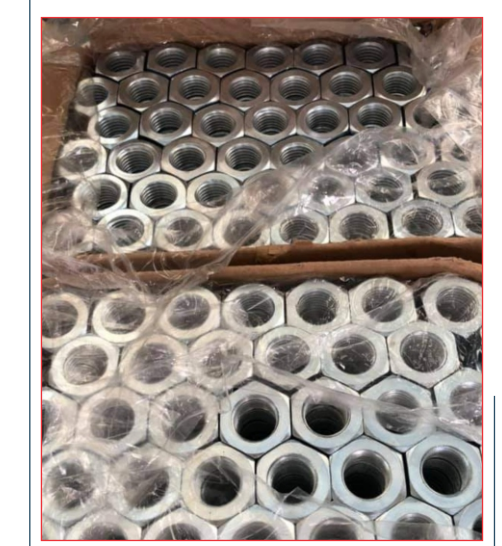

Packing

Thanks for your Precious Time



www.facebook.com/NGASALES CORPORATION/



www.googleMaps/NGA SALES CORPORATION/



www.Linkedin/NGA SALES CORPORATION



CORPORATE OFFICE

2729/2, Street no. 1,
Baba Gajja Jain Colony, Moti Nagar,
Ludhiana -141010, Punjab (INDIA)
Mobile: +91-78375-77000, 82830-59778
Email: ngasales777@gmail.com

